

# Defibtech DDU-2000 Series Automated External Defibrillator

- **DDU-2300**
- **DDU-2400**
- **DDU-2450**



## Operating Guide

## Notices

Defibtech, L.L.C. shall not be liable for errors contained herein or for incidental or consequential damages in connection with the furnishing, performance, or use of this material.

Information in this document is subject to change without notice. Names and data used in the examples are fictitious unless otherwise noted.

For more detailed information regarding the Defibtech DDU-2000 Series AED, please refer to the User Manual on the Defibtech User CD.

## Limited Warranty

The “Limited Warranty” shipped with Defibtech AED products serves as the sole and exclusive warranty provided by Defibtech, L.L.C., with respect to the products contained herein.

## Copyright

Copyright © 2015 Defibtech, L.L.C.

All rights reserved. Copyright questions should be directed to Defibtech. For contact information, refer to the “Contacts” section of this guide.

## Tracking

U.S.A. federal regulations require Defibtech to maintain records for each AED it distributes (reference 21 CFR 821, Medical Device Tracking). These requirements also apply anytime there is a change in the AED’s location, including if you move, sell, donate, give away, export or even throw it away. We depend on AED owners/users/holders to contact us when these things happen to ensure the tracking information remains accurate in the event we need to share important product notices. If your location is outside the U.S.A., we ask you share your information for exactly the same reasons. To keep your information up to date, please inform Defibtech using the information in the “Contacts” section contained in this document.



**Federal Law (USA) restricts this device to sale by or on the order of a physician.**

## Contents

<b>Quick Use Instructions.....</b>	<b>4</b>
<b>When To Use .....</b>	<b>5</b>
<b>Diagram Of Components.....</b>	<b>6</b>
<b>Setting Up The AED.....</b>	<b>8</b>
<b>Using The AED .....</b>	<b>10</b>
<b>Using The AED - ECG Display Monitor (DDU-2400 &amp; DDU-2450 only)....</b>	<b>14</b>
<b>Using The AED - Manual Mode (DDU-2400 only) .....</b>	<b>15</b>
<b>Checking AED Status .....</b>	<b>17</b>
<b>Routine Maintenance.....</b>	<b>18</b>
<b>The Defibrillation Pads.....</b>	<b>19</b>
<b>The Battery Pack.....</b>	<b>20</b>
<b>Dangers, Warnings, And Cautions.....</b>	<b>22</b>
<b>Technical Specifications.....</b>	<b>24</b>
<b>Warranty Information.....</b>	<b>26</b>
<b>Contacts.....</b>	<b>27</b>

*This DDU-2000 Series Operating Guide  
is to be used for quick reference.  
For comprehensive information go to the  
User Manual on the Defibtech User CD.*

**PRESS "ON" BUTTON**

1

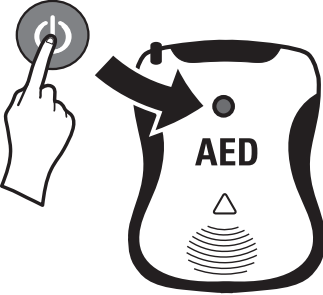

**APPLY PADS**

**FOLLOW AED INSTRUCTIONS**

2

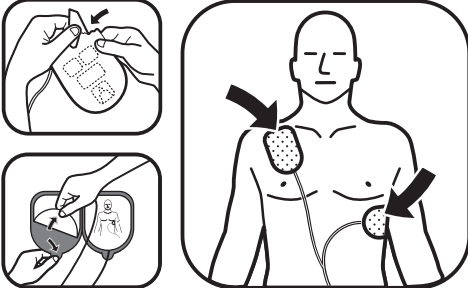

**IF INSTRUCTED, PRESS "SHOCK" BUTTON**

3



**DDU-2300 USAGE**

**Indications** – The DDU-2300 Semi-Automatic External Defibrillator (AED) is indicated for use on victims of sudden cardiac arrest (SCA) who are: **(1)** Unconscious and unresponsive; **(2)** Not breathing.

For patients under 8 years old or less than 55 pounds (25kg), use child/infant electrode pads. Do not delay therapy to determine exact age or weight.

Federal Law (USA) restricts this device to sale by or on the order of a physician.

**Contraindications** – The AED should not be used if the patient shows any of the following signs: **(1)** Conscious and/or responsive; **(2)** Breathing; **(3)** Has a detectable pulse.

**Operator Training Requirements** – In order to safely and effectively operate the AED, a person shall have met the following requirements: **(1)** AED and/or defibrillation training as required by local, state, provincial, or national regulations; **(2)** Any additional training as required by the authorizing physician; **(3)** Thorough knowledge and understanding of the material presented in the User Manual (on the Defibtech User CD).

**DDU-2400 & DDU-2450 USAGE**

**Indications** – The DDU-2400 and DDU-2450 Semi-Automatic External Defibrillator (AED) is indicated for use on victims of sudden cardiac arrest (SCA) who are: **(1)** Unconscious and unresponsive; **(2)** Not breathing.

For patients under 8 years old or less than 55 pounds (25kg), use child/infant electrode pads. Do not delay therapy to determine exact age or weight.

Federal Law (USA) restricts this device to sale by or on the order of a physician.

**Operator Training Requirements** – In order to safely and effectively operate the AED, a person shall have met the following requirements: **(1)** AED and/or defibrillation training as required by local, state, provincial, or national regulations; **(2)** Any additional training as required by the authorizing physician; **(3)** Thorough knowledge and understanding of the material presented in the User Manual (on the Defibtech User CD).

Manual Mode (DDU-2400 only) is intended for use only by qualified medical personnel trained in advanced life support skills and ECG recognition who want to deliver a shock independent of AED Mode.

ECG Monitor Mode (DDU-2400 and DDU-2450 only) is intended to be used by personnel trained in basic life and/or advanced life support, or other physician-authorized emergency medical training. Users should be trained in ECG recognition to allow for rhythm and heart rate monitoring using standard ECG monitoring electrodes.

# DIAGRAM OF COMPONENTS

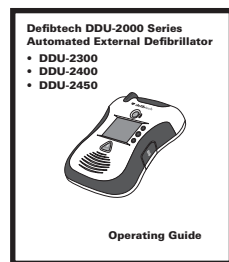
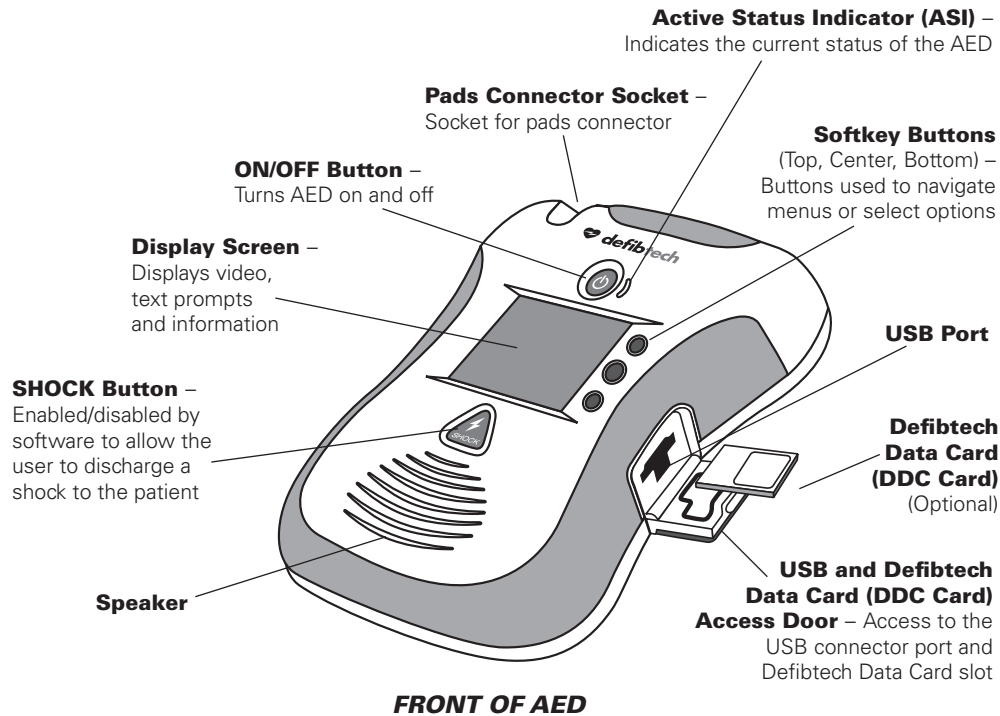

## OPERATING GUIDE BOOKLET

Quick Reference



## DEFIBTECH USER CD

Comprehensive User Manual can be found on the CD

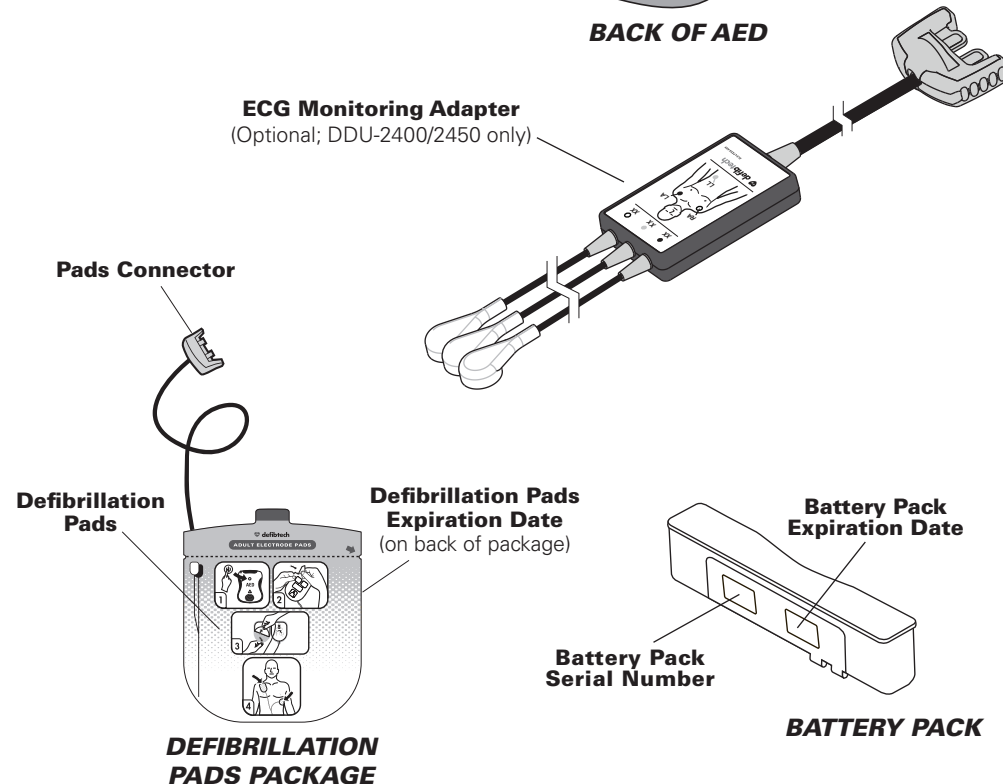
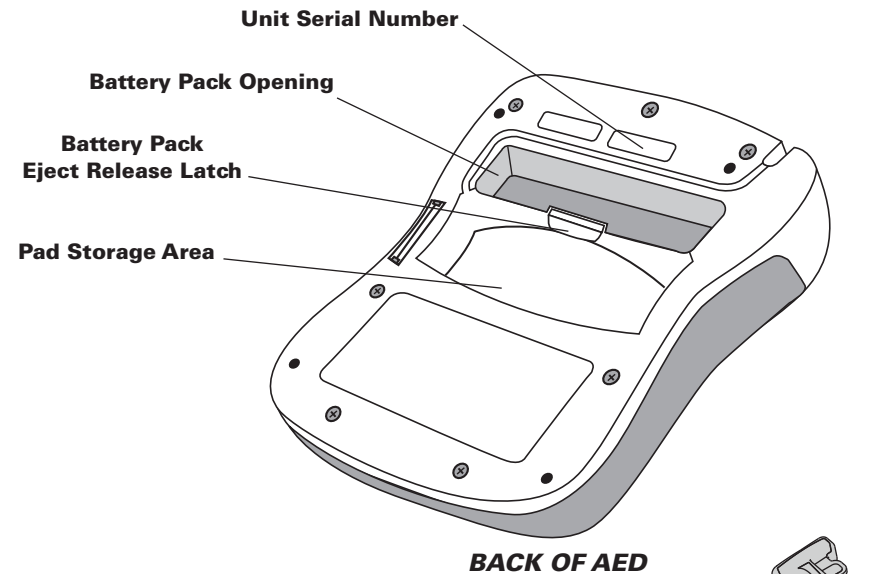

The DDU-2000 Series AED is designed to be stored in a "ready" state so that few steps are required to begin using the AED.

## CONNECT THE PADS TO THE AED

# 1

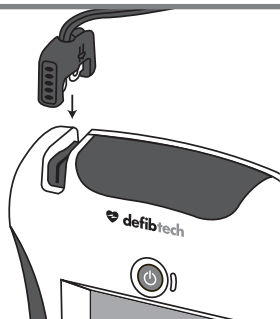

Ensure that the pads package has not expired.  
Expired pads must not be used.

For more information refer to page 18 of this guide.

## INSTALL THE BATTERY PACK

# 2

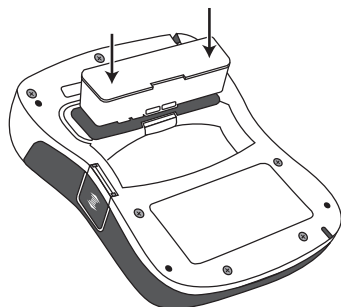

Ensure that the battery pack has not expired.  
Expired battery packs must not be used.

When the battery pack is installed, the AED will turn on and run a battery pack test. Wait for the test to complete and for the unit to turn off.

For more information refer to page 19 of this guide.

## CHECK THE STATUS

# 3

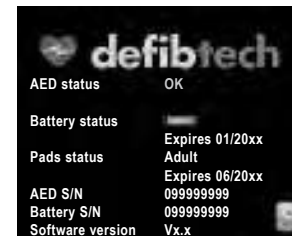

AED Status screen

With the AED off, press and release the CENTER softkey button. Ensure that the AED Status screen appears and that the "AED Status" is "OK".

## AND

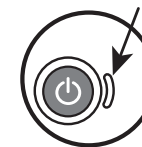

When the AED is off, the Active Status Indicator (ASI) should flash green. If the ASI flashes red, is solid red, or if there is no flashing light, the unit requires service.

For more information refer to page 16 of this guide.

## READ THE USER MANUAL (CD)

# 4



Comprehensive information about the DDU-2000 Series AED is found in the User Manual (on Defibtech User CD).



**Turn the unit ON and then follow the voice and display instructions.**

**TURN  
AED ON**

**1**

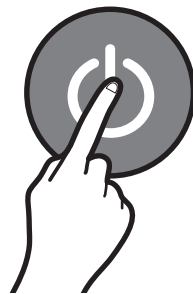

Press "ON" button

**PREPARE  
THE PATIENT**

**2**

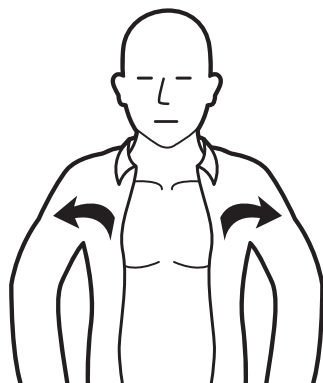

Remove clothing from patient's chest.  
If necessary, dry chest and remove excess chest hair.

**PREPARE  
ELECTRODE  
PADS**

**3**

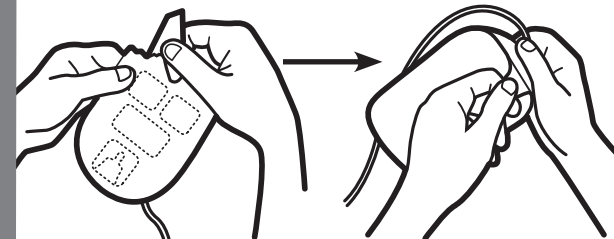

Tear open  
pads package

Peel pads  
from blue liner

**PLACE PADS**

**4**

**ADULT  
PATIENT**

**CHILD/INFANT  
PATIENT**

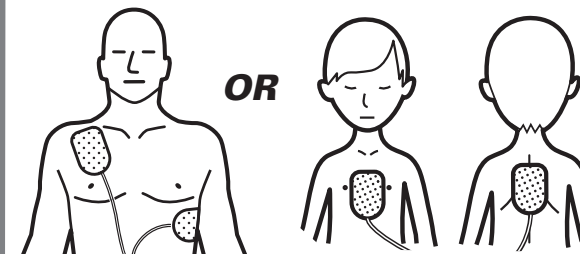

Apply pads to patient's  
bare chest as shown



**Note:** When this **Information Softkey Icon** is present on the screen, the user may press the corresponding softkey button for additional information with video instruction. To exit, press the softkey button again.

**STAND CLEAR**

**5**

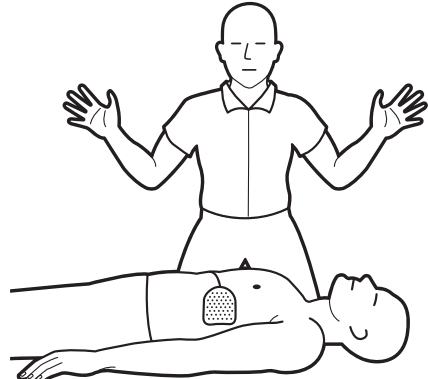

When instructed, do not touch the patient

**IF INSTRUCTED,  
PRESS SHOCK  
BUTTON**

**6**



If instructed, press "SHOCK" button



**Note:** When this **Information Softkey Icon** is present on the screen, the user may press the corresponding softkey button for additional information with video instruction. To exit, press the softkey button again.

**PERFORM CPR**

**7**

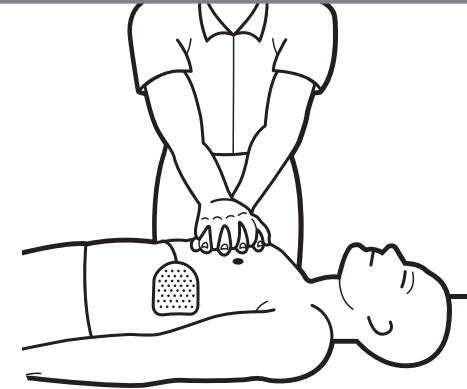

Follow instructions to perform CPR

**CONTINUE  
TO FOLLOW  
INSTRUCTIONS**

**8**

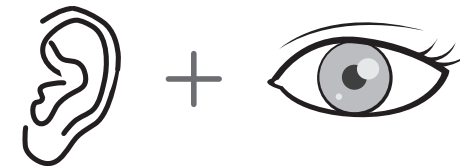

Continue to follow the voice  
and display instructions



## USING THE AED - ECG DISPLAY MONITOR (DDU-2400 AND DDU-2450 ONLY)

### SELECTING ECG DISPLAY\*

The DDU-2400 and DDU-2450 allow the user to display the patient ECG when the unit is being used as an AED.



To select ECG display, press the bottom softkey button next to the **Mode Select Icon** (shown at left) to bring up the **Mode of Operation** screen (shown at right).

**Operation** screen (shown at right).

Press the corresponding softkey (bottom button) to select **AED / ECG Mode**.

**\*NOTE:** On units running software version 2.4 or higher, the DDU-2400's factory default setting is **AED / ECG Mode** and the DDU-2450's factory default setting is **AED / Video Mode**. On DDU-2400 and DDU-2450 units running earlier software versions, the factory setting is **AED / Video Mode**.

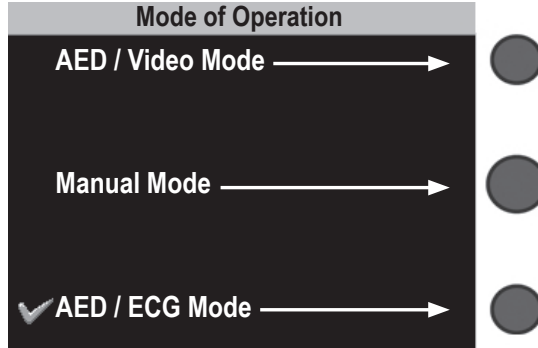

**Mode of Operation screen**  
(with corresponding softkey buttons)

### USING THE 3-LEAD ECG MONITORING ADAPTER

The DDU-2400 and DDU-2450 allow the user to perform 3-lead monitoring using the optional ECG Monitoring Adapter (DAC-2020/2021).

To enable ECG Monitor Mode, unplug the defibrillation pads and plug the ECG Monitoring Adapter into the pads connector socket. The AED will automatically switch to ECG Monitor Mode.

To perform a rescue, unplug the ECG Monitoring Adapter and plug in the defibrillation pads.



**ECG Monitor Mode screen**



The ECG Display provides non-diagnostic ECG of the patient's heart rhythm. It is not intended to provide diagnostic or ST segment interpretation.

## USING THE AED - MANUAL MODE (DDU-2400 ONLY)

The DDU-2400 AED provides a Manual Mode to override the AED features of the defibrillator. Manual Mode provides operator-initiated analysis, charge, shock, and disarm functions and is intended for use by qualified medical personnel trained in advanced life support skills and ECG recognition who want to deliver a shock independent of AED Mode.



The DDU-2400 Manual Mode Charge feature is intended for use only by authorized operators who have been specifically trained in cardiac rhythm recognition and in manual defibrillation therapy.

### SELECTING MANUAL MODE



To select Manual Mode, press the bottom softkey button next to the **Mode Select Icon** (shown at left) to bring up the **Mode of Operation** screen (shown at right).

Press the corresponding softkey (middle button) to select **Manual Mode**.

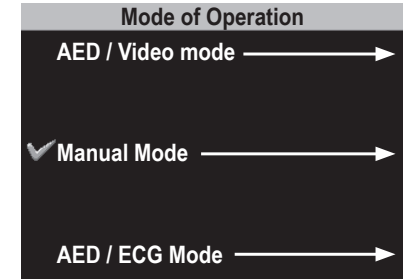

**Mode of Operation screen**

**ACCESS PROTECTION** (on DDU-2400 units running software version 2.4 or higher; units running earlier software versions will go directly to Manual Mode after it is selected from the Mode of Operation screen): When the Manual Mode softkey is pressed, the AED will prompt the user to confirm that they wish to enter into Manual Mode. Pressing the bottom softkey near the red "X" icon will cancel the operation and bring the user back to the Mode of Operation screen; pressing the top softkey will invoke Manual Mode. **(NOTE: For added protection, there is no onscreen icon for confirming entry into Manual Mode.)**

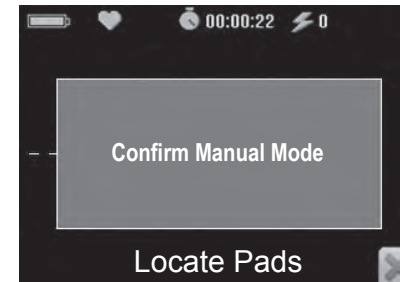

**Access Protection screen**



← Press to enter Manual Mode



← Press to cancel Manual Mode





For more detailed information, refer to the User Manual (on Defibtech User CD).

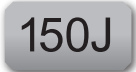

**USING MANUAL MODE**

While in Manual Mode, pressing the softkey associated with the icons below allows the user to:

-  **Energy Select:** Select the desired energy level (top button).
-  **CHARGE:** Initiates a charge (middle button).
-  **DISARM:** Cancels a charge (middle button after a charge is initiated).

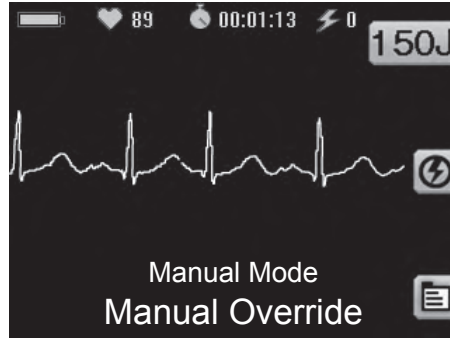

**Manual Mode screen**

When charging is complete, press the flashing SHOCK button.

**ACTIVE STATUS INDICATOR (ASI)**

Visually check the Active Status Indicator (ASI) **on a daily basis**. The ASI should flash green. If the ASI flashes red, is solid red, or if there is no flashing light, the unit requires service. Anytime the ASI flashes red, the unit will also “beep” periodically to call attention to itself.

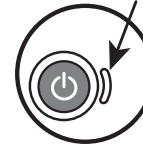

**Active Status Indicator**

- **Flashing Green:** The DDU-2000 Series AED is OFF and ready for use.
- **Solid Green:** The DDU-2000 Series AED is ON and ready for use.
- **Flashing or Solid Red:** The DDU-2000 Series AED needs immediate service. Refer to the “*Troubleshooting*” section of the User Manual (on Defibtech User CD) or call Defibtech for service.
- **No Flashing Light:** The DDU-2000 Series AED needs immediate service. Refer to the “*Troubleshooting*” section of the User Manual (on Defibtech User CD) or call Defibtech for service.

**AED STATUS SCREEN**

The AED Status screen is used to provide a quick overview of the DDU-2000 Series AED’s status and to display select information without turning the unit on for a rescue.

With the AED off, press and release the **CENTER** softkey button to display the AED Status screen. The AED Status screen will be displayed for a short period of time.

If the unit does not turn on at all, check to make sure a good battery pack is installed. (Refer to the “*Troubleshooting*” section of the User Manual (on Defibtech User CD).

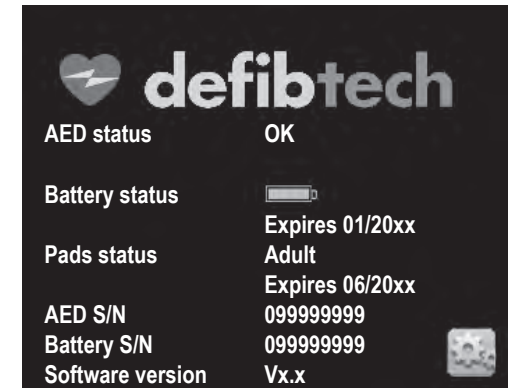

**AED Status screen**

The DDU-2000 Series AED is designed to be very low maintenance. Simple maintenance tasks are recommended to be performed regularly by the owner/operator to ensure its dependability (see sample maintenance table below). Different maintenance intervals may be appropriate depending on the environment where the AED is deployed, and ultimately the maintenance program is at the discretion of the emergency response program's medical director.

Daily	Monthly	After Each Use	Action
●	●	●	<b>Check that the Active Status Indicator is flashing green</b>
	●	●	<b>Check the condition of the unit and accessories</b>
		●	<b>Run manually initiated self-test</b>
		●	<b>Replace pads</b>
	●		<b>Check pad and battery pack expiration dates</b>
		●	<b>Check the DDC card, if one was installed</b>

**Note:** If the unit has been dropped, mishandled, or abused, a manually initiated self-test should be performed.

If the unit needs attention, refer to the "Troubleshooting" section of the User Manual (on Defibtech User CD) or call Defibtech for service. For contact information, refer to the "Contacts" section of this guide.

## MAINTENANCE MODE

Maintenance Mode permits the user to perform maintenance-related actions such as viewing unit information, initiating unit self-tests, changing unit parameters, downloading rescue data, and upgrading software.

 To enter Maintenance Mode press the bottom softkey button to the right of the **Tool Icon** (shown at left) on the AED Status screen (for instructions on how to access the AED Status screen, see previous page). To exit Maintenance Mode, simply turn the unit off by pressing the ON/OFF button. For comprehensive information about Maintenance Mode, refer to Chapter 8 of the User Manual (on Defibtech User CD).

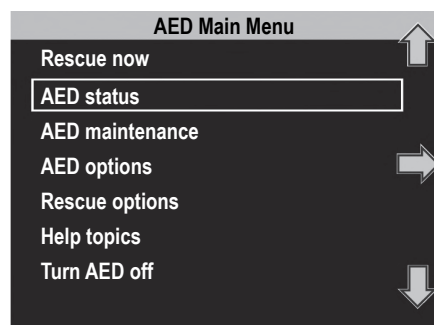

**The display screen during Maintenance Mode**

## HOW TO CONNECT THE PADS

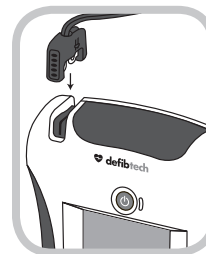

Insert the connector end of the defibrillation pad cable into the pads connector socket on the top-left corner of the DDU-2000 Series AED as shown. Insert pads connector firmly until it is fully seated in the unit. The connector will only fit in one way – if the connector does not fit, rotate the connector before trying again.

The connected pads package can then be stored in the pad storage area on the back of the DDU-2000 Series AED (see diagram on page 7).

After connecting the pads connector to the unit, push the pads package, rounded end first, with the pictures on the package facing out, into the pad storage area. When the pads package is fully inserted, press the pad cable into the groove in the back of the unit to hold the cable in place and tuck any excess cable behind the pads package.

## WHICH PADS TO USE

### ADULT PADS

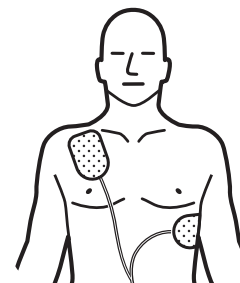

**For adults and children 8 years or older or over 55 pounds (25 kg), use adult pads**

### CHILD/INFANT PADS

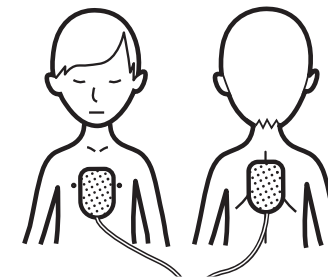

**For infants and children under 8 years or less than 55 pounds (25 kg), use child/infant pads (Note: child/infant pads can be identified by their blue connector and blue pads package)**

## WHEN TO REPLACE THE PADS

The Defibtech defibrillation pads are intended for one time use only. The pads must be replaced after each use or if the package has been damaged.

It is important to check the expiration date of the pads. The expiration date is printed on the outside of the sealed package. *Do not use pads past their expiration date.* Discard expired pads. *Use only Defibtech defibrillation pads.*

You may also check the status of the pads when the unit is off by pressing the center softkey button to display the AED Status screen and enter Maintenance Mode.

### HOW TO INSERT AND REMOVE THE BATTERY PACK

Before inserting the battery pack into the DDU-2000 Series AED, ensure that the battery pack opening in the back of the AED is clean and clear of any foreign objects. Insert the battery pack into the opening in the back of the AED.

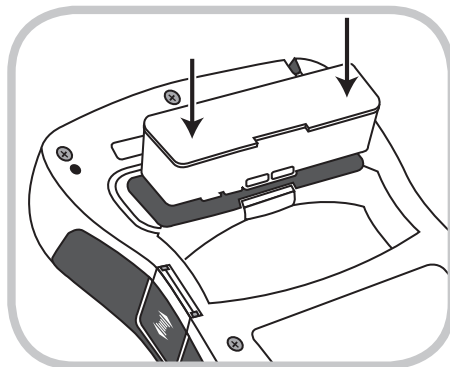

Push the pack all the way in until the latch clicks. The battery pack will only fit in one way. If the battery pack does not fit, rotate the battery pack before trying again. Once fully inserted, the battery pack surface should be flush with the back of the AED. Within moments of insertion, the DDU-2000 Series AED will turn on and run a battery pack insertion test. When the test is completed the unit will report the status of the battery pack and shut down. (The battery pack must be removed from the unit for more than 10 seconds for the battery pack self-test to be performed automatically.)

To remove the battery pack, push the battery pack eject release latch. After the battery pack is partially ejected, pull the battery pack out.

### WHEN TO REPLACE THE BATTERY PACK

It is important to check the expiration date of the battery pack. The expiration date is printed on the label on the battery pack. *The battery pack should be used before the expiration date.* When the battery pack is low, the unit will indicate "battery low" or "replace battery now" and the Active Status Indicator will flash red. The battery pack should be replaced immediately. *Use only Defibtech battery packs.*

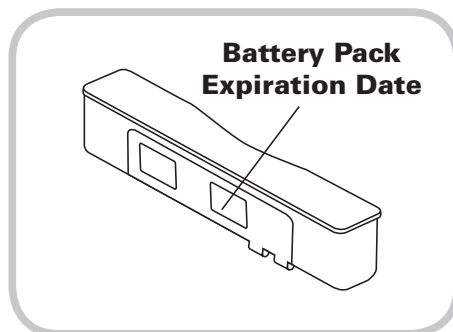

You may also check the status of the battery pack when the unit is off by pressing the center softkey button to display the AED Status Screen and enter Maintenance Mode.

*This page intentionally left blank.*



**DANGERS:**

**Immediate hazards that will result in serious personal injury or death.**

- Hazardous electrical output. This equipment is for use only by qualified personnel.
- Possible fire or explosion. Do not use in the presence of flammable gases or anesthetics. Use care when operating this device close to oxygen sources (such as bag-valve-mask devices or ventilator tubing). Turn off gas source or move source away from patient during defibrillation, if necessary.
- The DDU-2000 Series AED has not been evaluated or approved for use in hazardous locations as defined in the National Electric Code standard. In compliance with IEC classification, the DDU-2000 Series AED is not to be used in the presence of flammable substance/air mixtures.

**WARNINGS:**

**Conditions, hazards, or unsafe practices that may result in serious personal injury or death.**

- Improper use can cause injury. Use the DDU-2000 Series AED only as instructed in the User Manual. The DDU-2000 Series AED delivers electrical energy that can potentially cause death or injury if it is used or discharged improperly.
- Improper maintenance can cause the DDU-2000 Series AED not to function. Maintain the DDU-2000 Series AED only as described in the User Manual. The AED contains no user serviceable parts – do not take the unit apart.
- No modification of this equipment is allowed.
- Electrical Shock Hazard. Dangerous high voltages and currents are present. Do not open unit, remove cover (or back), or attempt repair. There are no user serviceable components in the DDU-2000 Series AED. Refer servicing to qualified service personnel.
- Lithium battery packs are not rechargeable. Any attempt to recharge a lithium battery pack may result in fire or explosion.

**WARNINGS (continued)**

- Do not immerse battery pack in water or other liquids. Immersion in fluids may result in fire or explosion.
- Do not let fluids get into the DDU-2000 Series AED. Avoid spilling fluids on the AED or its accessories. Spilling fluids into the DDU-2000 Series AED may damage it or cause a fire or shock hazard.
- Do not sterilize the DDU-2000 Series AED or its accessories.
- Use only Defibtech disposable self-adhesive defibrillation pads, battery packs, and other accessories supplied by Defibtech or its authorized distributors. Substitution of non-Defibtech approved accessories may cause the device to perform improperly.
- Do not open sealed pads package until pads are to be used.
- Do not touch the patient during defibrillation. Defibrillation current can cause operator or bystander injury.
- Do not allow pads to touch metal objects or equipment in contact with the patient. Do not touch equipment connected to the patient during defibrillation. Disconnect other electrical equipment from the patient before defibrillation.
- Do not shock with defibrillation pads touching each other. Do not shock with gel surface exposed.
- Do not allow defibrillation pads to touch each other, or to touch other ECG electrodes, lead wires, dressings, transdermal patches, etc. Such contact can cause electrical arcing and patient skin burns during defibrillation and may divert defibrillating energy away from the heart.
- The defibrillation pads are intended for one time use only and must be discarded after use. Reuse can lead to potential cross infection, improper performance of the device, inadequate delivery of therapy and/or injury to the patient or operator.
- Avoid contact between parts of the patient's body and conductive fluids such as water, gel, blood or saline, and metal objects, which may provide unwanted pathways for defibrillating current.
- Disconnect all non-defibrillator proof equipment from the patient before defibrillation to prevent electrical shock hazard and potential damage to that equipment.

**WARNINGS (continued)**

- Aggressive or prolonged CPR to a patient with defibrillation pads attached can cause damage to the pads. Replace the defibrillation pads if they become damaged during use.
- Possible Radio Frequency (RF) interference from RF devices such as cellular phones and two-way radios can cause improper AED operation. Normally using a cell phone near the AED should not cause a problem; however, a distance of 2 meters (6 feet) between RF devices and the DDU-2000 Series AED is recommended.
- CPR during analysis can cause incorrect or delayed diagnosis by the patient analysis system.
- Handling or transporting the patient in any way during ECG analysis can cause incorrect or delayed diagnosis, especially if very low amplitude or low frequency rhythms are present. If the patient is being transported, stop vehicle before beginning ECG analysis.
- In patients with cardiac pacemakers, the DDU-2000 Series AED may have reduced sensitivity and not detect all shockable rhythms. If you know the patient has an implanted pacemaker, do not place electrodes directly over an implanted device.
- During defibrillation, air pockets between the skin and defibrillation pads can cause patient skin burns. To help prevent air pockets, make sure self-adhesive defibrillation pads completely adhere to the skin. Do not use dried out or expired defibrillation pads.
- User-initiated and automatic self-tests are designed to assess the DDU-2000 Series AED's readiness for use. However, no degree of testing can assure performance or detect abuse, damage, or a defect that occurred after the most recent test is completed.
- Use of damaged equipment or accessories may cause the device to perform improperly and/or result in injury to the patient or operator.
- The DDU-2400 Manual Mode Charge feature can deliver dangerous energy when used inappropriately; Manual Mode is intended for use by authorized operators who have been specifically trained in cardiac rhythm recognition and in manual defibrillation therapy.

**WARNINGS (continued)**

- Possible misinterpretation of ECG data. The frequency response of the LCD display is intended for basic ECG rhythm identification; it does not provide the resolution required for pacemaker pulse identification or accurate measurements, such as QRS duration and ST segment interpretation. For such purposes an ECG Monitor with an appropriate frequency response should be used.
- Follow voice prompts if the LCD screen becomes blank or unreadable.

**CAUTIONS:**

**Conditions, hazards, or unsafe practices that may result in minor personal injury, damage to the DDU-2000 Series AED, or loss of data.**

- Follow all battery pack labeling instructions. Do not install battery packs after the expiration date.
- Follow all defibrillation pad label instructions. Use defibrillation pads prior to their expiration date. Do not re-use defibrillation pads. Discard defibrillation pads after use (in the event of suspected pad malfunction, return pads to Defibtech for testing).
- Recycle or dispose of lithium battery packs in accordance with local, state, provincial, and/or national regulations. To avoid fire and explosion hazard, do not burn or incinerate the battery pack. Do not crush.
- Use and store the DDU-2000 Series AED only within the range of environmental conditions specified in the technical specifications.
- If possible, disconnect the DDU-2000 Series AED from the patient prior to use of other defibrillators.
- Do not connect the DDU-2000 Series to a PC or other device (using the USB port) while the unit's electrodes are still connected to the patient.
- Using non Defibtech Data Cards (DDC cards) may damage the unit and will void the warranty.
- Although the DDU-2000 Series AED is designed for a wide variety of field use conditions, rough handling beyond specifications may result in damage to the unit.
- Federal Law (USA) restricts this device to sale by or on the order of a physician.



## OPERATING MODES

### AED MODE (ALL MODELS)

High resolution video display (animated instructions and CPR coaching)

### ECG MONITOR MODE (DDU-2400 & 2450 ONLY)

Displays ECG data and event information (with 3-lead electrodes)

### MANUAL MODE (DDU-2400 ONLY)

Displays ECG data and event information and defibrillation energy selection from 25-200 Joules with charge, shock and disarm control

## DEFIBRILLATOR

### TYPE

Semi-Automatic external defibrillator

### MODEL

DDU-2000 Series

### WAVEFORM

Impedance Compensated Biphasic Truncated Exponential

### RESCUE PROTOCOL

AHA/ERC 2010 Supports protocol updates by the user (password protected)

### ENERGY\*

AED Mode:  
Adult: 150 Joules  
Child/Infant: 50 Joules  
Manual Mode:  
Adult: User selectable from 25-200 Joules  
Child/Infant: User selectable from 25-100 Joules (50 Joules only when using DDP-2002 attenuating pediatric defibrillation pads)

### CHARGE TIME

AED Mode:  
4 seconds or less (from shock advised)\*\*  
Manual Mode:  
9 seconds or less (150 Joules)\*\*\*  
12 seconds or less (200 Joules)\*\*\*

### CONTROLS

Lighted ON/OFF button  
Lighted Shock button

### DISPLAY

High-resolution color LCD

### VIDEO PROMPTS

Full motion video  
On-screen text prompts

### CPR COACHING

Video and voice coaching  
On-demand video help

### VOICE PROMPTS

Extensive voice prompts guide user through operation of the unit.

\*Nominal into 50 ohm load  
\*\*Typical, new battery, at 25°C  
\*\*\*Typical, new battery depleted by 6 shocks, at 25°C

## PATIENT ANALYSIS SYSTEM

### PATIENT ANALYSIS

Automatically evaluates patient impedance for proper pad contact. Monitors signal quality and analyzes patent ECG for shockable/non-shockable rhythms.

### SENSITIVITY/SPECIFICITY

Meets AAMI-DF-80 specifications and AHA recommendations.

## BATTERY PACKS

### MODEL

DBP-2003 (standard),  
DBP-2013  
(aviation; TSO C-142a)

### POWER

12VDC, 2800 mAh

### TYPE

Lithium/Manganese Dioxide Disposable, recyclable, non-rechargeable

### CAPACITY\*

125 shocks or 8 hours continuous operation

### STANDBY LIFE\*

4 years

### LOW BATTERY INDICATIONS

Visible  
Audible

\*Typical, new battery, at 25°C

## SELF-TESTS

### AUTOMATIC

Automatic daily, weekly, monthly and quarterly circuitry tests

### BATTERY INSERTION

System integrity test on battery insertion

### PAD PRESENCE

Pads preconnected tested daily

### USER-INITIATED

Unit and battery pack system test initiated by the user

### STATUS INDICATION

Visual and audible indication of unit status

### STATUS SCREEN

Unit self-tests results  
Pads and battery information (status and expiration)

## DEFIBRILLATION / MONITORING PADS

### MODEL

Adult – DDP-2001  
Child/Infant –  
DDP-2002 and DDP-2003

### SURFACE AREA

Adult – 77cm<sup>2</sup> (nominal, each pad)  
Child/Infant –  
50cm<sup>2</sup> (nominal, each pad)

### TYPE

Pre-connected, single-use, non-polarized, disposable, self-adhesive electrodes with cable and connector

## EVENT DOCUMENTATION

### INTERNAL EVENT RECORD

Critical ECG segments and rescue event parameters are recorded (greater than 60 minutes) and can be downloaded to a removable data card.

### PC-BASED EVENT REVIEW

ECG with event tag display, and audio playback when available.

### REMOVABLE STORAGE

(optional) Up to 30 hours of ECG and event data storage (no audio option) or up to 3 hours of audio (audio option).

ECG and event storage on a removable data card. Actual length of storage is dependent on card capacity.

### USB PORT

Event download and maintenance operations.

## ENVIRONMENTAL

### TEMPERATURE

Operating: 0 to 50°C (32 to 122°F)  
One Hour Operating Temperature Limit (extreme cold)\*: -20°C (-4°F)  
Standby: 0 to 50°C (32 to 122°F)

Jet Aircraft (RTCA/DO-160D Section 8, Cat H, Zone 2, Curves B & R)

### RELATIVE HUMIDITY

Operating/Standby: 5%-95% (non-condensing)

### ALTITUDE

-500 to 15,000ft (-150 to 4500m) per MIL-STD-810F 500.4 Procedure II

### VIBRATION

Ground (MIL-STD-810F 514.5 Category 20)

Helicopter (RTCA/DO-160D, Section 8.8.2, Cat R, Zone 2, Curve G)

### SHOCK/DROP ABUSE TOLERANCE

MIL-STD-810F 516.5 Procedure IV 48 inches (1.2 meters), any edge, corner, or surface, in standby mode

### CRUSH TEST

1,000 pounds (450kg)

### SEALING/WATER RESISTANCE

IEC 60529 class IP55; Dust protected, Protected against water jets (battery pack installed)

### ESD

IEC 61000-4-2: (Open air up to 15kV or direct contact up to 8kV)

### EMC (Emission)

CISPR 11 Group 1 Level B and FCC Part 15

### EMC (Immunity)

IEC 61000-4-3 and IEC 61000-4-8

### AIRCRAFT

Meets RTCA/DO-160G, Section 21, RF Radiated Emissions, Category M

\*From room temperature to temperature extreme, one hour duration, updated specification for DDU-2000 Series AEDs running software revision 2.4 or above.

## PHYSICAL

### SIZE

7.3 x 9.5 x 2.3 inches (18.5 x 24 x 5.8 cm)

### WEIGHT

Less than 3 lbs (1.4kg) (with battery)



0197



**ORIGINAL END USER'S LIMITED WARRANTY\***

**COVERAGE**

Defibtech, LLC provides a limited warranty that the defibrillator and its associated accessories (e.g., batteries and pads), whether purchased concurrently with the defibrillator as part of a configuration or separately, shall be substantially free from defects in material and workmanship. Defibtech's limited warranty shall only extend to the original end user, where the original end user purchased the items from an authorized Defibtech, LLC retailer. This limited warranty may not be assigned or transferred. The terms of the limited warranty in effect as of the date of original purchase shall apply to any warranty claims.

**LENGTH OF WARRANTY**

The defibrillator's limited warranty is for a period of eight (8) years from the date of purchase. The battery's limited warranty is for a period of four (4) years from the date of purchase, but in no event shall the limited warranty period extend past the date printed on the battery. Single use accessories (e.g., the pads) shall have a limited warranty up to use or for a period up to the expiration date, whichever is earlier. The limited warranty for all other accessories is for a period of one (1) year from the date of purchase, or to the expiration date, whichever is earlier.

**LIMITED WARRANTY LIMITATIONS**

This limited warranty does not cover damage of any sort resulting from, but not limited to, accidents, improper storage, improper operation, alterations, unauthorized service, tampering, abuse, neglect, fire, flood, war, or acts of God. Additionally, this limited warranty does not cover damage of any sort to the defibrillator or its associated accessories resulting from the use of the defibrillator with unapproved accessories or use of the accessories with unapproved medical devices. The defibrillator and its associated accessories are not warranted to be compatible with any other medical device.

**LIMITED WARRANTY VOIDED**

The limited warranty is immediately voided if: the defibrillator or its associated accessories are serviced or repaired by any entity, including persons, not authorized by Defibtech, LLC; specified maintenance is not performed; the defibrillator is used with one, or more, unauthorized accessories; the associated accessories are used with an unauthorized defibrillator; or the defibrillator or associated accessories are not used in accordance with Defibtech, LLC approved instructions.

*\*Applicable to defibrillators and associated accessories having a date of manufacture on or after January 1, 2013. For all others, refer to warranty information in effect at the time of manufacture.*

**EXCLUSIVE REMEDY**

At Defibtech, LLC's sole discretion, Defibtech shall have the option to repair, replace, or provide a credit. In the event of replacement, Defibtech shall have the right at its sole discretion to replace the item with a new, or refurbished, same or similar item. Determination of a similar item shall be at the sole discretion of Defibtech. In the case of replacement, the replacement at a minimum shall reflect the prorated time remaining for the item based on the remaining limited warranty period. In the case of a credit, the credit shall be the prorated value of the item based on the lower of the original item cost of the same or similar item and the remaining limited warranty period. In no event, shall the limited warranty period of a replacement item extend past the limited warranty period of the item it is replacing.

**WARRANTY SERVICE**

In order to obtain warranty service, contact the retailer from whom the item was purchased, or Defibtech, LLC customer service. In the event an item must be returned, a Return Material Authorization (RMA) number is required. Items returned without an RMA number will not be accepted. The item shall be shipped at the original end user's expense to a destination specified by the retailer or Defibtech, LLC.

**OBLIGATIONS AND WARRANTY LIMITS**

THE FOREGOING LIMITED WARRANTY IS IN LIEU OF AND SPECIFICALLY EXCLUDES AND REPLACES, TO THE DEGREE PERMITTED BY APPLICABLE STATE LAW, ALL OTHER EXPRESS OR IMPLIED WARRANTIES, INCLUDING, BUT NOT LIMITED TO, THE IMPLIED WARRANTIES OF MERCHANTABILITY AND FITNESS FOR A PARTICULAR PURPOSE.

NO PERSON (INCLUDING ANY AGENT, DEALER, OR REPRESENTATIVE OF DEFIBTECH, LLC) IS AUTHORIZED TO MAKE ANY REPRESENTATION OR WARRANTY CONCERNING THE DEFIBRILLATOR OR ITS ASSOCIATED ACCESSORIES, EXCEPT TO REFER TO THIS LIMITED WARRANTY.

THE EXCLUSIVE REMEDY WITH RESPECT TO ANY AND ALL LOSSES OR DAMAGES RESULTING FROM ANY CAUSE WHATSOEVER SHALL BE AS SPECIFIED ABOVE. DEFIBTECH, LLC SHALL IN NO EVENT BE LIABLE FOR ANY CONSEQUENTIAL OR INCIDENTAL DAMAGES OF ANY KIND, INCLUDING, BUT NOT LIMITED TO, EXEMPLARY DAMAGES, SPECIAL, PUNITIVE, COMMERCIAL LOSS FROM ANY CAUSE, BUSINESS INTERRUPTION OF ANY NATURE, LOSS OF PROFITS OR PERSONAL INJURY, EVEN IF DEFIBTECH, LLC HAS BEEN ADVISED OF THE POSSIBILITIES OF SUCH DAMAGES, HOWEVER OCCASIONED, WHETHER BY NEGLIGENCE OR OTHERWISE, UNLESS APPLICABLE STATE LAW DOES NOT ALLOW SUCH EXCLUSION OR LIMITATION.

**Manufacturer**



Defibtech, L.L.C.  
741 Boston Post Road, Suite 201  
Guilford, CT 06437 USA

Tel.: 1-(866) 333-4241 (Toll-free within North America)

1-(203) 453-4507

Fax: 1-(203) 453-6657

Email:

sales@defibtech.com

(Sales)

reporting@defibtech.com

(Medical Device Reporting)

service@defibtech.com

(Service and Repair)

Patents pending.

This product and its accessories are manufactured and sold under one or more of the following United States patents: D523,393, D548,346, D551,628.

This product and its accessories are manufactured and sold under license to at least one or more of the following United States patents: 5,591,213; 5,593,427; 5,601,612; 5,607,454; 5,611,815; 5,617,853; 5,620,470; 5,662,690; 5,735,879; 5,749,904; 5,749,905; 5,776,166; 5,800,460; 5,803,927; 5,836,978; 5,836,993; 5,879,374; 6,016,059; 6,047,212; 6,075,369; 6,438,415; 6,441,582.

**European Authorized Representative**



Emergo Europe  
Molenstraat 15  
2513 BH The Hague  
The Netherlands